





# ASSEMBLY INSTRUCTIONS

## 2512 - Grenville Desk

NO.	ITEM	DESCRIPTION	QTY.
1		M8x30	18 pcs
2		Ø8	18 pcs
3		Ø8	18 pcs
4		M6	1 pc

1. Pull out 4 side drawers
2. Place the top upside down on a protected surface. Attach the Legs frame to the top using bolt (1), washers (2) and (3). Check all screw are fully tightened.
3. Re-install drawers.
4. Assembly is complete.

Step 1.

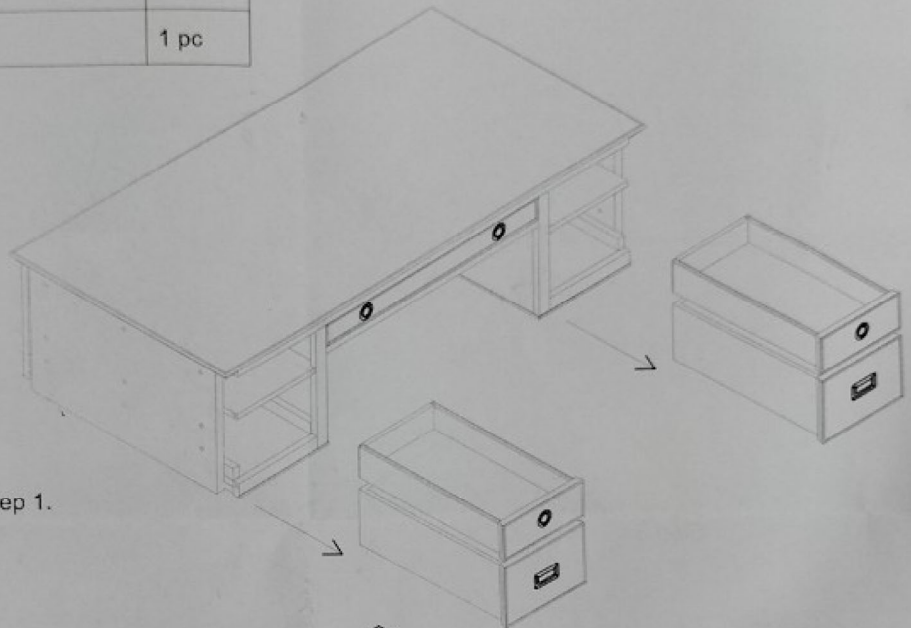

temporary support

temporary support

Step 2.

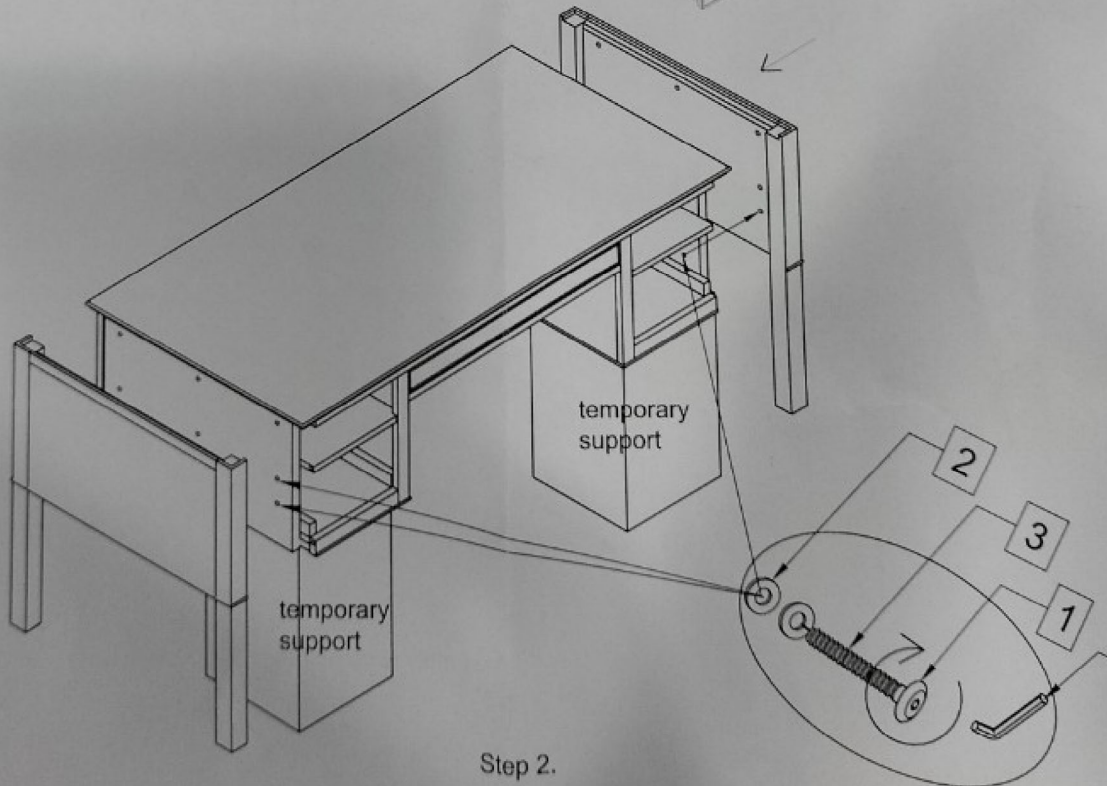

# ASSEMBLY INSTRUCTIONS

2512 - Grenville Desk

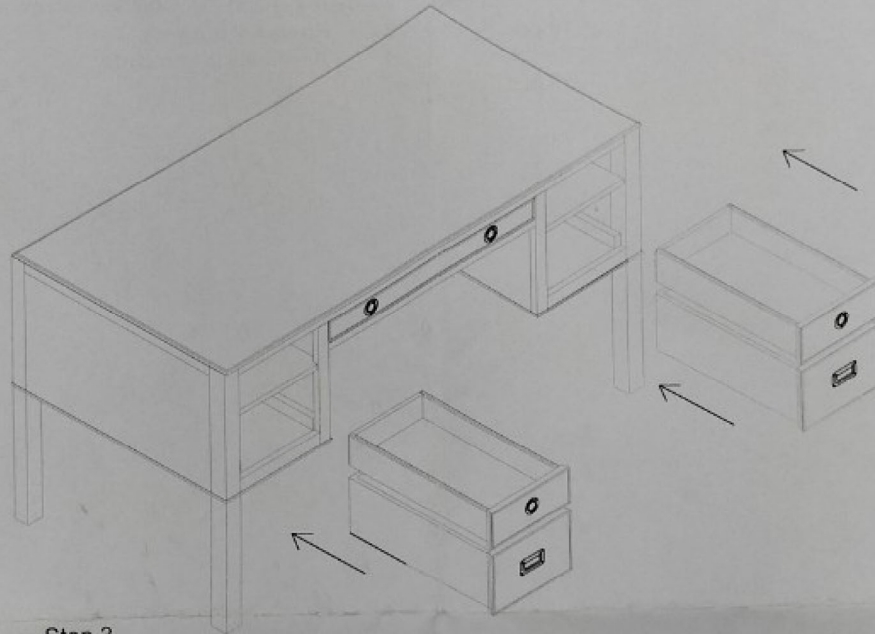

Step 3.



Assembly is complete.